



INTELLISPEC™

CP500S Hardware Guide Series V

SOFTWARE VERSION: 5.6

MANUAL PART NUMBER: 81017 REV. 01

Copyright Notice / Contact Us

© 2020 Pressco Technology Inc. All rights reserved.

No part of this manual may be reproduced or transmitted in any form or by any means, electronic or mechanical, including photocopying and recording, for any purpose, without the express written permission of Pressco Technology Inc.

The contents of this manual are furnished for informational use only, are subject to change without notice, and should not be construed as a commitment by Pressco Technology Inc.

Written and designed at:

Pressco Technology Inc. World Headquarters

29200 Aurora Road

Cleveland, OH USA 44139-1847

TEL +1-440-498-2600

FAX +1-440-498-2615

www.pressco.com

Business Hours: Monday - Friday, 8:00am - 5:00pm Eastern Time

Customer Support:

Request technical support and remote support: techsupport@pressco.com

24/ 7 Customer Support (for urgent system help): +1-440-498-2000

e-mail: Schedule a service visit: dispatch@pressco.com

Request technical support and remote support: techsupport@pressco.com

Customer Service Fax: +1-440-498-4761

Table of Contents

Chapter 1 Pressco Introduction	5
About This Manual	5
Safety Considerations	6
Static Discharge Protection	6
Chapter 2 Declaration of Conformity - Intellispec System	7
Chapter 3 Safety Information	9
Health Warning - Photosensitive Epilepsy	9
Symbols Used With This System	10
Label Description - Intellispec	10
Warning Devices	11
Light Tree	11
Residual Risk	11
Intended Use	12
Prohibited Use	12
Personal Protective Equipment	12
Personnel Safety	13
Lifting Heavy Objects	14
Authorized Users	14
Spare Parts Usage	15
Chapter 4 System Specifications	16
Environmental Conditions	16
Sound Pressure Level	16
Chapter 5 Installation	18
Shipping and Handling	18
Recommendations Prior to Installation	18
Assembly, Location, and Mounting Requirements	19
Utilities to be Supplied by Customer	19

Protective Earthing	19
Electrical Connection	20
Installation	20
Ventilation	20
Commissioning	20
Chapter 6 CP500s Module	22
CP500s Dimensions	22
Inspection Module Adjustments	23
Observe the Part Image	23
Adjust the Camera in the CP500s Module	24
Wiring Diagram CP500s	25
Maintenance for the CP500s	26

Chapter 1 Pressco Introduction

Welcome!

Congratulations on your purchase of an Intellispec system! The Intellispec is a high-speed machine vision system designed specifically for product and online process monitoring. It is a powerful tool that provides inspection much more reliably than the human eye or sampling methods. The latest PC technology, powerful inspection algorithms, online adjustment capability, and inspection data storage allow the Intellispec to automatically inspect parts with extreme accuracy on high-speed lines.

The Intellispec will help you provide the highest quality of products shipped to your customers.

About This Manual



IMPORTANT: *Keep this manual for future reference*

This book is considered an integral part of the system and should be kept handy for future reference as long as the system is being used in your plant.

The purpose of this manual is to describe all of the features in the software. It is intended for Administrators and trained users.

This manual:

- Is considered to be valid for Intellispec version 5.7. Contents of this manual are subject to change without notice.
- Is your responsibility to keep in good condition, in a dry place, and ready for consultation by the authorized users of the system.
- Contains the technology implemented at the time of selling and supplying the system and shall not be considered inadequate in case of technological enhancements in the machine or in the manual's illustrations.

Related books include:

- Intellispec Series V Operator's Guide which has Operator-level user instructions, and is a good place to start if you are new to Intellispec
- Intellispec Software Guide which has Administrator-level user instructions
- Intellispec Series V Hardware Guide (multiple options)

The following types of alerts may appear in this guide:



DANGER! - *Danger messages alert you to specific conditions that can cause serious or fatal personal injury. Danger messages give you important information which must be observed to prevent injury.*



WARNING: - *Warning messages indicate information which must be observed to prevent injury, data loss, or equipment damage.*



CAUTION - *Caution messages indicate important information which must be observed to prevent: loss of data, poor system performance, or equipment damage.*

Note: Notes contain special information that warrants being set off from the body text as shown here.

 **IMPORTANT** - Indicates prerequisites or information that must be observed to complete or understand a concept or task.

TIP: Provides helpful hints for completing a task.

Safety Considerations

Observe the following safety warnings when operating the system or working near it:

 **Warning** - Potential for projectiles to strike persons and cause injury. Keep clear of reject devices.

 **Warning** - Sensitive electronics and High Voltages may be exposed. Keep Processor Cabinet/ Electrical Control Box door closed.

Static Discharge Protection

 **Caution** - Electronic components can be damaged by static electricity discharge.

Always observe the following precautions before removing, installing or handling any electronic components within the Inspection System:

- Wear an anti-static wristband which is grounded to the Inspection System.
- Stand on an anti-static, grounded floor mat, and lay circuit boards on the mat during any board replacement.
- Keep circuit boards in static shield bags when storing and transporting. Ensure the bag is sealed.

Chapter 2 Declaration of Conformity - Intellispec System

Declaration	<p>The listed product is in conformity with following Union harmonization legislation:</p> <p>Directive 2014/30/EU of the European Parliament and of the Council of 26 February 2014 on the harmonisation of the laws of the Member States relating to electromagnetic compatibility and with Directive 2014/35/EU of the European Parliament and of the Council of 26 February 2014 on the harmonisation of the laws of the Member States relating to the making available on the market of electrical equipment designed for use within certain voltage limits.</p> <p>The Technical Documentation demonstrates the fulfillment of the essential requirements as set out in Annex I of the above Directive.</p>
Manufacturer	<p>Pressco Technology Inc. 29200 Aurora Road Cleveland, Ohio 44139-1847 USA</p> <p>This declaration of conformity is issued under the sole responsibility of the manufacturer.</p>
Product Name	Intellispec Series V Inspection System
Referenced harmonised standards to which conformity is declared:	<p>EN 61326-1:2013 Electrical equipment for measurement, control and laboratory use — EMC requirements — Part 1: General requirements</p> <p>EN 55011:2009 +A1:2010: Radiated / Conducted Emissions</p> <p>EN 61000-4-2:2009: ESD Immunity</p> <p>EN 61000-4-3:2006 + A1:2008 + A2:2010: Radiated RF Immunity</p> <p>EN 61000-4-4:2004 + A1:2010: EFT Burst Immunity</p> <p>EN 61000-4-5:2006: Surge Immunity</p> <p>EN 61000-4-6:2009: Conducted RF Immunity</p> <p>EN 61000-4-11:2004: Voltage Dips & Interruptions</p> <p>EN 61010-1:2010 Safety requirements for electrical equipment for measurement, control, and laboratory use - Part 1: General requirements</p>
Technical File	EMR2932 & ES2932
Place	Pressco Technology Inc. 29200 Aurora Road Cleveland, Ohio 44139-1847 USA

Signed for and on behalf of Pressco Technology Inc., 29200 Aurora Road, Cleveland, OH USA 44139:

 VP, ENG. OPERATIONS

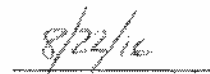

Name, Position

Date

Chapter 2

Signed: Fredrick F. Awig, VP of Engineering & Operations. Signed for and on behalf of Pressco Technology Inc.

Date: 22 August 2016

Chapter 3 Safety Information

This section contains operator safety information that must be read before operating or servicing the system.

 **WARNING** - This product contains no operator serviceable parts. Refer servicing to qualified personnel. To prevent electrical shock do not open cabinet doors whilst power is connected.

 **WARNING** - Do not, under any circumstances, tamper with sealed machine parts or devices. This could result in the removal of protections that might create potentially hazardous conditions.

 **CAUTION** - Possible hazardous optical radiation from LEDs. Do not stare at lamps.

Health Warning - Photosensitive Epilepsy

 **WARNING: PHOTSENSITIVE EPILEPSY/ SEIZURES**

A small percentage of individuals may experience epileptic symptoms or seizures when exposed to certain patterns or flashing lights. Exposure to the flashing lights in vision inspection systems may also trigger epileptic symptoms or seizures in these individuals. These flashing lights may trigger epileptic symptoms or seizures in persons who have no history of epileptic symptoms or seizures. If you, or anyone in your family has an epileptic condition or has had seizures of any kind, consult your physician before operating this machinery.

IMMEDIATELY DISCONTINUE use and consult your physician if you experience any of the following symptoms while operating this machinery:

- Dizziness
- Altered vision
- Eye or muscle twitches
- Loss of awareness
- Disorientation
- Seizures
- Any involuntary movement or convulsion

Epileptic symptom or seizure triggers vary from person to person. Some common triggers are:









- Flashing lights used for vision inspection systems or fire alarms
- Certain video games or TV broadcasts containing rapid flashes or alternating patterns of different colors
- Bright, contrasting patterns such as white bars against a black background
- Flashing white light followed by darkness
- Stimulating images that take up your complete field of vision, such as being very close to a TV screen or computer monitor
- Certain colors, such as red and blue

If you encounter something that might trigger epileptic symptoms or seizures without warning:

- Do not close your eyes (this could cause a flicker effect)
- Do not look directly at the flashing lights or trigger source
- Do cover one eye with the palm of your hand immediately
- Do turn away from the flashing lights or trigger source

Symbols Used With This System

The following symbols are used on or near the Pressco system. Be aware of potential risk hazards.

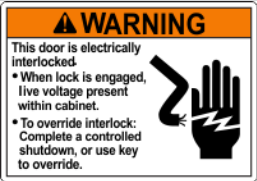
Symbol	Meaning
	CAUTION Risk of danger. Refer to accompanying user documentation before use.
	WARNING Risk of electric shock
	WARNING Risk of burns from hot surface
	WARNING Hand crush hazard
	On (supply)
	Off (supply)
	Alternating current
	Protective conductor terminal
	Arc flash and shock hazard
	Electrical interlock

Label Description - Intellispec

The following illustration shows an example label that you will find on the Intellispec system components.

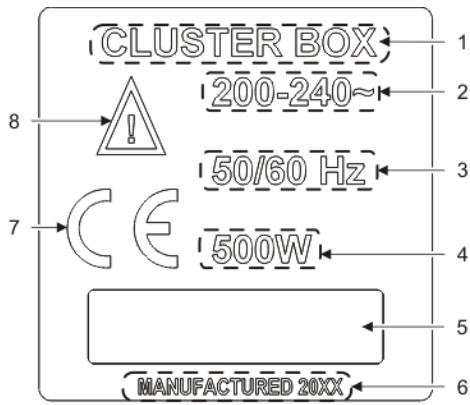

- 1) Name of component. NOTE: The Chromapulse model is listed on the front panel of the module.
- 2) Voltage range in Volts AC
- 3) Frequency range in Hertz (Hz)
- 4) Maximum rated power in watts (W) with all accessories or plug-in modules connected
- 5) Serial number is listed in this box
- 6) Year of manufacture
- 7) Component certification
- 8) Risk of danger. Refer to accompanying documentation before use.

Warning Devices

The Pressco system has warning devices that indicate system failure or report excessive defects or warnings for your production line. These include an optional light tree, alarms and indicators on screen, and audible warnings (depending on system).

Light Tree

The optional light tree is mounted on a pole in a customer-specified location.



The light tree color segments represent each alarm or system condition. A color segment may appear for more than one alarm condition.

Residual Risk

The Pressco system has been designed to minimize any danger of personal injury. However, the system uses rejection devices to remove defective product from the production stream. Also, the electronics cabinets contain risk of shock if they are opened.

Observe the following safety warnings when operating the system or working near it:



WARNING - Potential for projectiles to strike persons and cause injury. Keep clear of reject devices.



WARNING - Sensitive electronics and High Voltages may be exposed. Keep Processor Cabinet/ Electrical Control Box door closed.

Intended Use

Type of Process The Pressco system is intended to monitor container and other special manufacturing processes and identify non-conforming product.

Intended Use The Pressco system is designed and constructed for use in an indoor industrial environment, always sheltered from the weather.

Space Required The Pressco system and accompanying sensors must be installed in a place that will enable safe and easy installation, size changeover, user operation, and maintenance procedures.

Prohibited Use



WARNING - If this instrument is not used as specified, the protection provided by the equipment could be impaired. This instrument must only be used in a normal condition (in which all means of protection are intact).



Important - The Pressco system should NOT be used for any purpose other than specifically indicated in the section titled "Intended Use" above.

The following uses **are not** intended:



Use in an explosive environment



Use in a flammable environment



Use in a damp, moist, or wet environment, except where specifically indicated

Personal Protective Equipment



Important - Always follow the safety requirements of your plant in addition to the recommendations below.

We recommend, at minimum, use of the following Personal Protective Equipment (PPE):



Protective clothing



Protective gloves



Protective ear plugs or headphones



Protective eye wear



Protective foot wear

Personnel Safety

The following rules are recommended to ensure the safety of personnel in charge of machine operation and maintenance.

During machine operation:



Only one operator is needed to operate the machine. All others must keep at a safe distance.



Operators must be familiar with all machinery connected to the Pressco equipment and know how to use emergency stop devices.

Note: the emergency stop devices may not be connected directly to the Pressco equipment, but it is important to know how to use them.



Before putting the Pressco system online, the operator must ensure that all safety devices used with all connected machinery are in place and operational.

Do not operate with guards removed.



The operator must maintain maximum focus on his work and be alert throughout his shift. If this is not the case, immediately inform the shift supervisor.

When carrying out maintenance or repair work:



Disconnect master switch. For switch locations, refer to the Power Up and Power Down section.



Before starting the machine, ensure that no person is close to the machine.



If maintenance or repair requires the disconnection or removal of safety or protection systems, this operation must be supervised by authorized personnel who must ensure the prevention of personal injury or damage to the machine. All machine movements must be performed with limited speed and limited movements.



Maintenance or repair work on electrical components must be carried out exclusively by authorized, trained personnel. When running tests with power connected, you must strictly comply with the rules provided.



Personnel working on higher parts of a machine must wear a harness and hook it on to the structure and must always move with extreme caution.









Never perform lubrication or maintenance procedures on mechanical parts with the machine running.

For your safety, do not:



Open safety guards during machine operation

Chapter 3

-  Perform maintenance and repair while the system is running
-  Lean on the machine
-  Sit on the machine components
-  Use the machine for purposes other than those listed in this manual
-  Modify parts of the machine
-  Allow unqualified personnel to operate or perform maintenance procedures on the machine

Lifting Heavy Objects

 **CAUTION** - Some components are heavy. Take proper precautions to prevent personal injury or damage to equipment. If you are not capable of lifting the object alone, ask a capable person to help lift the object, or use a mechanical lifting device

The components do not have handles to lift the equipment. Be sure to:

- Lift equipment from the bottom - do not use wires, brackets, nor other protrusions
- Keep fingers away from sensor lenses to keep the equipment clean
- Proceed slowly

 **WARNING**- The Pressco cabinets must NOT be lifted by one person. Use a mechanical lifting device, and ask another person to assist you.

 Do not twist your body when moving the load. Instead take small steps with your feet turning until you are in the correct position.

To safely lift equipment:

1. Stand close to the load and center yourself over it with your feet shoulder width apart.
2. Tighten your abdominal muscles.
3. Keeping your back straight, bend your knees and squat down to the floor.
4. Get a good grasp on the load with both hands.
5. Keeping the load close to your body, use your leg muscles to stand up lifting the load off the floor. Your back should remain straight throughout lifting, using only the muscles in the legs to lift the load.
6. To place the load in the appropriate spot, bend at the knees using only your leg muscles to lower the load.

Authorized Users

Trained machine operators, mechanic and electrical maintenance staff, and plant managers are considered authorized users of the Pressco system. These users should carefully read the information contained in this manual. The plant manager must ensure that the safety recommendations included

in this manual are observed.



WARNING - *Allowing workers who are unfamiliar with the production process to operate the Pressco system could result in hazard risk.*

If you are unclear about any part of this manual, contact Pressco Technical Support.



Important - *No worker should ever operate the system outside of his/ her own area of competence and responsibility.*

Proper Operation: Only one worker is to operate the system at any given time. The correct position for the operator is in front of the user interface monitor or control enclosure (if applicable).

Repairs: Any repair on the system shall be carried out exclusively by Pressco Technology Inc. service personnel or by other service expressly authorized by Pressco Technology Inc.

Spare Parts Usage

The following restrictions apply to replacing parts:



WARNING - *Using spare parts that are not designed to Pressco's specifications can compromise the safety and effectiveness of the Pressco system.*

- The use of parts that are not within Pressco's design specifications is prohibited. This prohibition applies in particular when the parts involved contain or are connected with safety devices.
- Before resuming production, make sure all safety devices are in working order.

Pressco Technology Inc. shall not be liable in any way if any of the above-described directions are not complied with.

To obtain a spare parts list, contact the customer service department at Pressco.

Pressco's technicians are available to help customers, in their own plant, to solve any problem that might arise during use and maintenance of the system.

Chapter 4 System Specifications

This instrument has been designed and tested in accordance with Publication EN61010-1 (2010) Safety Requirements for Electrical Equipment for Measurement, Control and Laboratory Use and has been supplied in a safe condition. The instruction documentation contains information and warnings which must be followed by the user to ensure safe operation and to maintain the instrument in a safe condition.

Environmental Conditions

The Intellispec Series V system is designed to be safe in the following environmental conditions:

Note: Please consult Pressco Technology Inc. if your environmental conditions are outside of those listed.

Condition	Specifications
Indoor/ outdoor use	Indoor use only
Altitude	Up to 2000 meters
Operating Temperature	5 °C to 50 °C
Storage Temperature	0 °C to 70 °C
Humidity	Maximum relative humidity 80 % for temperatures up to 31 °C decreasing linearly to 50 % relative humidity at 50 °C
Mains supply	Voltage fluctuations up to ± 10 % of the nominal voltage
Overvoltage protection rating	Transient overvoltage typically present on MAINS supply NOTE: the normal level of transient overvoltages is impulse withstand (over-voltage) category II of IEC 60364-4-443.
Rated pollution degree	This instrument is designed for use in Installation Category II and Pollution Degree 1 as per EN61010-1 and EN60664 respectively.



Warning - This is a Class A product. In a domestic environment this product may cause radio interference in which case the user may be required to take adequate measures.

Sound Pressure Level

The horn on the optional light tree has a maximum 105dB level at 1 meter distance in front of the horn. Use proper hearing protection as specified by your plant safety instructions.

Chapter 4

This page left blank intentionally

Chapter 5 Installation

This section contains information about installation requirements and preparations that need to be complete before installing the system.

Shipping and Handling

Pressco Technology Inc. ships unassembled components in packing cases designed to protect the contents during handling and from exposure to weather.

Unless otherwise specified in the contract with the machine order, the Customer shall supply Pressco Technology Inc. with the means and equipment necessary for the unloading, lifting, and handling of machine parts. Pressco Technology Inc. deems it important to have one of their technicians supervise the process of unloading, handling, and lifting the machine. The technician can give useful advice as to the logical sequence in which the components should be unpacked and positioned for ease of assembly.



WARNING - Only qualified personnel must be involved in the operation of unloading, handling, and lifting the machine. Pressco Technology Inc. shall not be liable for damage to components and/or personal injury resulting from the involvement of unauthorized personnel and/or failure to comply with the directions provided in this manual in relation to lifting and transport.



Important - The site supervisor will be responsible for ensuring that all the various mounting phases are carried out safely and in compliance with current regulations.

After the machine is delivered, check for any damage that might have occurred during shipping. In case of damage, contact Pressco Technology Inc.

In handling the machine, always keep it close to the ground.



We recommend using a forklift truck with adequate capacity and forks to suit the weight to be lifted (machine plus packaging).

The dimensions and weight of a crate are listed below. Note that this is the maximum size and weight. The size and weight of the crate may be less depending on your configuration. You may receive multiple crates depending on your configuration.

Size	152.4 cm x 124.46 cm x 152.4 cm (60 x 49 x 60 inches)
Weight	453.592 kg (1000 lbs.)

Recommendations Prior to Installation

Before the machine is installed, the Pressco installer, together with the Customer (or representative) shall check the following criteria in the environment where the machine is to be installed:

- Work required by contract for the installation of the machine has been carried out
- The plant layout drawing that describes where the machine will be installed is the final drawing agreed to by Pressco Technology Inc.
- The space and height required for installation are actually available

- Only the components included in the installation layout are present in the area where the machine is to be mounted. Ensure no machines or components have been added at a later stage that might hinder mounting or make it more difficult. Should this be the case, immediately contact Pressco's Project Engineering personnel to arrange a suitable solution to the problem.

We recommend the following prior to machine installation:

- Transport the machine in its packaging to the area where it will be installed to minimize possibility of damage
- Carefully remove the packaging material and check components for damage
- Check tightness of mechanical components, as they can loosen during transport
- Prepare the compressed air mains line. Before making final connections, ensure that the pipes are clean and free from any debris.

Assembly, Location, and Mounting Requirements

Utilities to be Supplied by Customer

The following utilities are required to operate the Pressco Intellispec system. Before making connection, make sure the utility matches the technical specifications. More than one connection of the utilities may be required depending on the number of modules installed. Refer to specific wiring diagrams.

Utility	Requirements
Air supply for rejection device	Pipe size must be such that there will be no pressure decrease during machine operation. Air must be dry and free of oil.
Electrical supply	<p>Provide one each electrical socket to comply with:</p> <ul style="list-style-type: none"> • User interface electrical specifications (use the specifications that apply to your system) • Integrated tunnel electrical specifications (if applicable) • Cluster box electrical specifications (if applicable)
Internet connection (optional)	Provide a shielded ethernet cable to use Pressco's remote support through the Internet.

Protective Earthing

This product must be grounded (earthed). If it should malfunction or break down, grounding provides a path of least resistance for electric current to reduce the risk of electric shock.

 **DANGER** - Improper connection of the equipment grounding conductor can result in a risk of electric shock. Check with a qualified electrician or service technician if you are in doubt as to whether the product is properly grounded.

Cord Connected Equipment

The product will be equipped with a supply cord having an equipment grounding conductor and a grounding plug. The plug must be plugged into an appropriate outlet that is properly installed and grounded in accordance with local codes and ordinances.

Do not modify the plug provided with the product - if it will not fit the outlet, have a proper outlet installed by a qualified electrician.

Cable Direct

This product must be connected to a grounded metal, permanent wiring system, or an equipment grounding conductor must be run with the circuit conductors and be connected to the equipment grounding terminal.

Electrical Connection

Make sure that the power outlet voltage matches the voltage required by the machine. Refer to the specifications for equipment included with your system:

- **User Interface Electrical Specifications**
- **Integrated Tunnel Electrical Specifications** (if applicable)
- **Cluster Box Electrical Specifications** (if applicable)

 **WARNING** - Power Switch is the power disconnect device. Do not position the equipment such that access to the disconnect switch is impaired. If not readily accessible (such as within a rack or mounting out of reach), an additional disconnect device should be installed that can isolate the Live and Neutral lines of the mains power supply, whilst leaving the protective earth intact.

Installation

Pressco Technology Inc. recommends that the machine be installed and assembled by Pressco's specialized technicians. This is of vital importance for correct machine operation.

 **WARNING** - Pressco Technology Inc. shall not be liable in case of failures or damage to property and/or personal injury resulting from or connected with assembly if this has been carried out by unauthorized personnel, or is not in compliance with the indications given in this manual.

To carry out production and cleaning/ servicing operations, it is important for the machine to have a minimum amount of space all around and away from walls.

Ventilation

Place the Pressco Intellispec components in a position with adequate ventilation to allow proper air flow through the air filters.

Component	Spacing
User Interface	Leave 1 meter [39 inches] clear around machine
Cluster box (not used on all systems)	Leave 100 mm clear in front of the fan and vent

Commissioning

Before placing the machine into operation, make sure the following checks are completed:

Completed	Yes	No
Positioning and leveling of the unit		

Chapter 5

Completed	Yes	No
Connection of compressed air line to connection points		
Connection of power supply to vision processor cabinet		
Connection of power supply to cluster box (if applicable)		
Connection of power supply to integrated inspection module(s) if applicable		
Proper wiring from user interface cabinet to sensor module(s) and cluster box (if applicable) using the wiring diagrams		

Chapter 6 CP500s Module

The CP500S Inspection module inspects the plastic closure for ovality, contamination, correct orientation, color, etc.

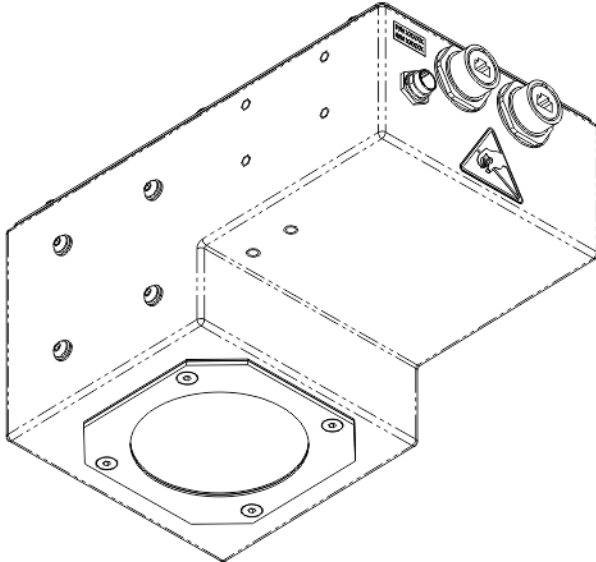

Bottom view

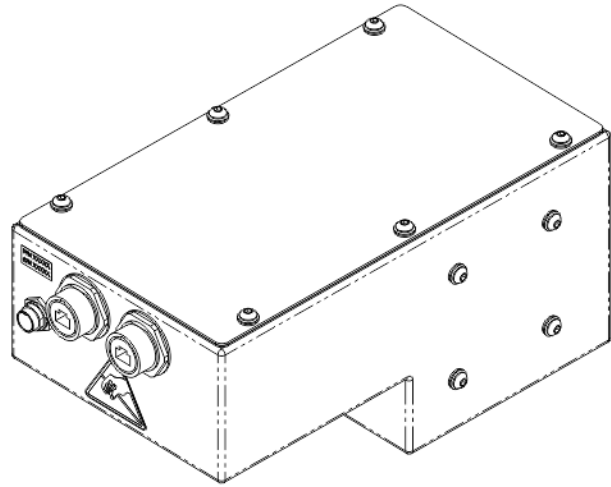

Top view

CP500s Dimensions

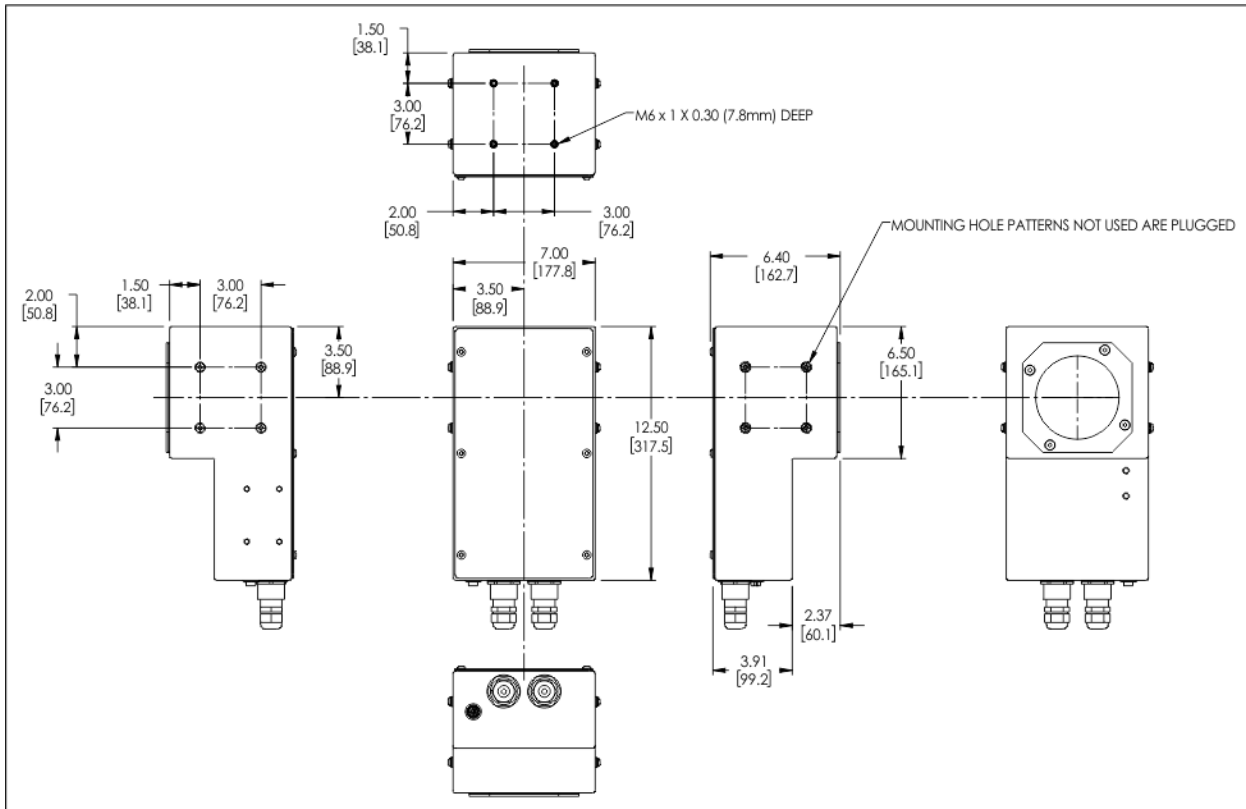

The measurements are in inches. The numbers in brackets are in millimeters.

Inspection Module Adjustments

Inspection module adjustments include the camera position, aperture, and camera focus.

The focus adjustment controls the clarity of the image; the aperture adjustment controls the amount of light admitted by the shutter. Normally the inspection modules do not require further adjustment after initial system setup. Circumstances that might require additional adjustments are camera replacement, strobe replacement, or a substantial change in part size or color.

⚠ Danger - The inspection modules are mounted near moving machinery. Use extreme caution to avoid contact with moving machinery when servicing inspection modules as serious personal injury could result. Ensure machinery is in an emergency stop state before servicing inspection modules.

Observe the Part Image

When adjusting the focus, aperture, or height for any inspection module, it is helpful to use Offline Imaging so that you can immediately see the effect of an adjustment on the image quality.



To use Run in Immediate Mode:

1. Make sure the lane is offline.



2. Right-click a sensor button.
3. Select Offline Imaging from the menu.
4. Click the **Run** button under **Immediate Mode**, then run a part through the inspection module.

While the system is in this mode, you will be able to make adjustments to focus, aperture, or camera height.

Adjust the Camera in the CP500s Module

1. Carefully remove the six fasteners and remove the cover of the module.

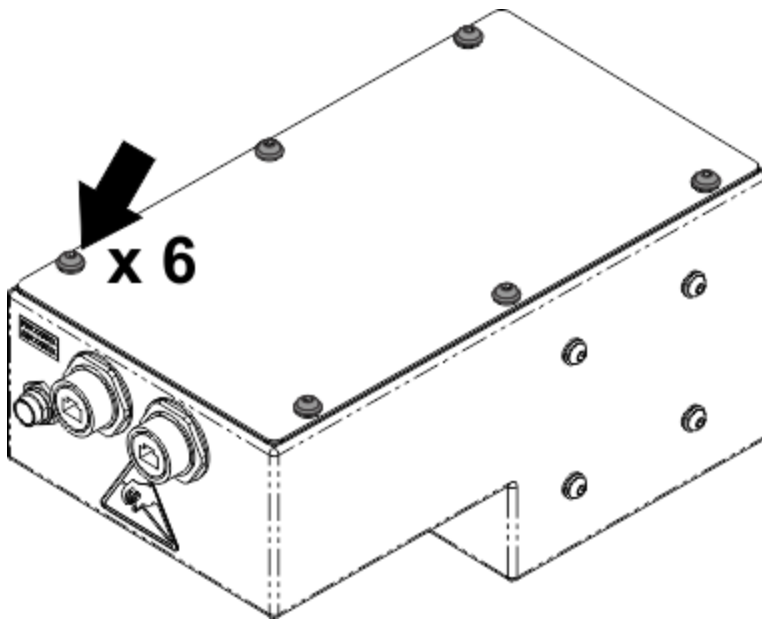

Note: the stop lever [1] is set at the factory. This is a stop for the optimal camera position. You do not need to adjust item [1] unless you have a large change in part size, or are instructed by Pressco.

2. Observe the Part Image on the monitor.
3. Unlock the top lever [2] to lift the camera, so that you can access the camera lens.

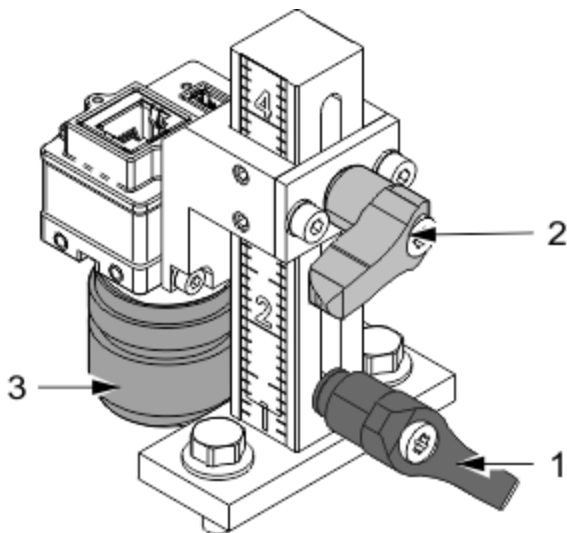

4. Make adjustments to focus and aperture with the appropriate rings on the lens [3].
5. Move the camera back to its original position (at the stop lever [1]). Make sure the focus and aperture are still good.
6. Lock the top lever [2].
7. Replace the cover and six fasteners.

Wiring Diagram CP500s

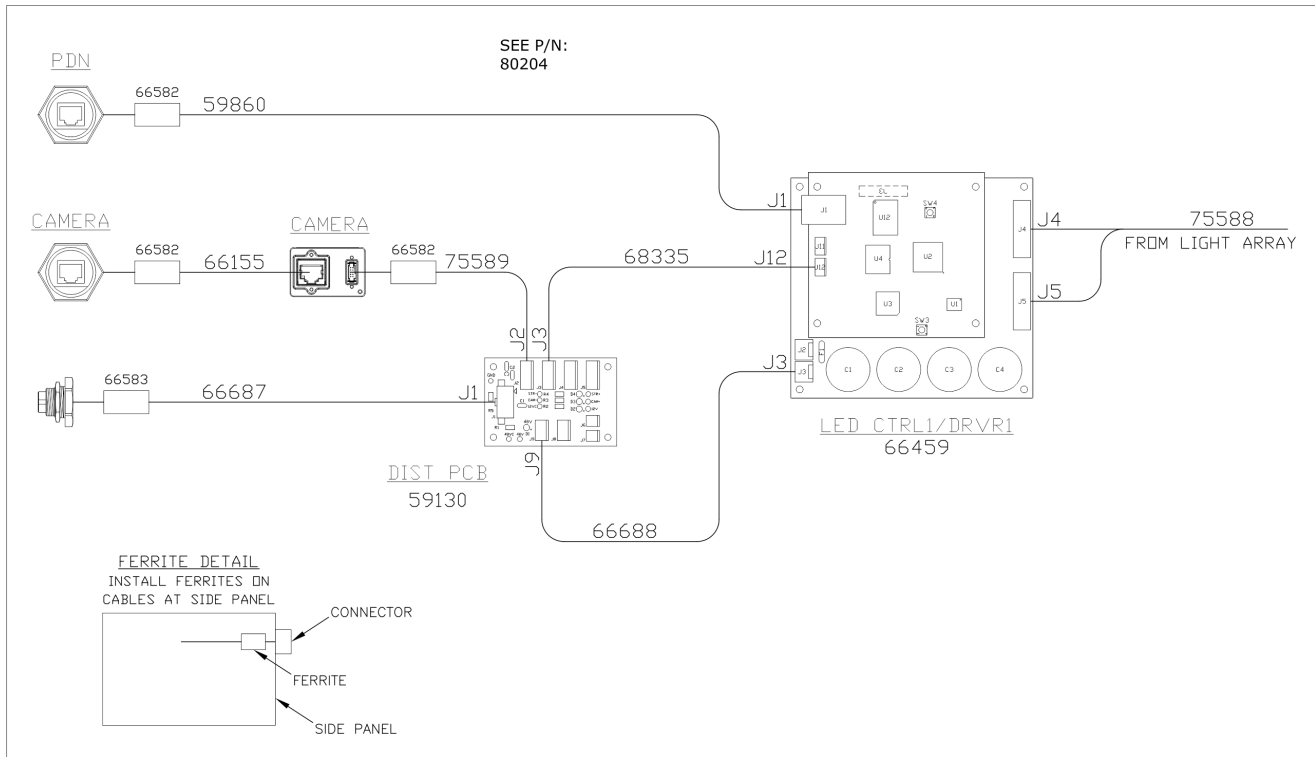

Maintenance for the CP500s

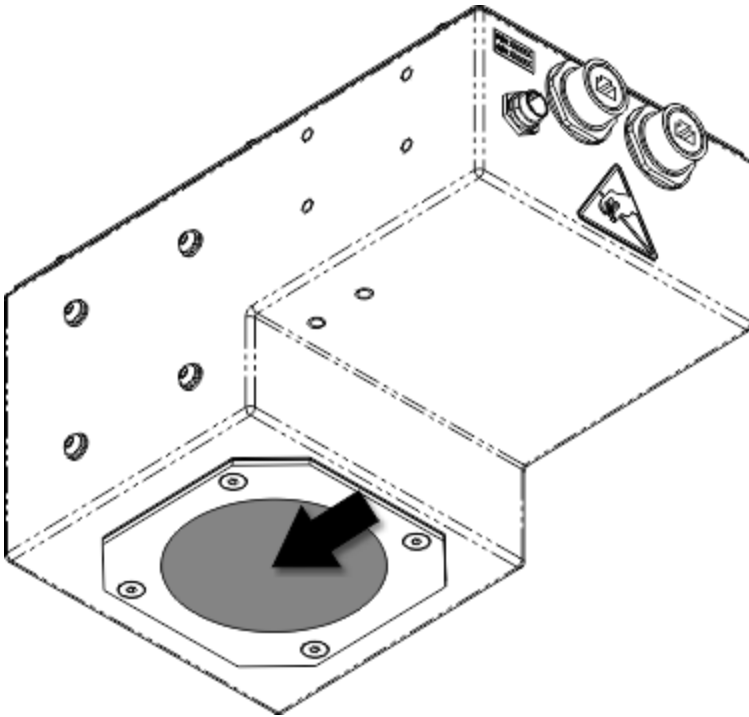

Clean the window(s) on the inspection module once per month.

Note: Cleaning frequency will depend on plant and process conditions.

To clean plastic surfaces:

- Use canned compressed air to blow away dust
- Use a clean, non-abrasive cloth dampened with mild soap and water solution. Saturate surface completely to let particles wash away.
- Dry the surface with clean, compressed air

Do not:

- Wipe away dirt - plastic coating may be scratched
- Use paper towels or paper napkins – these may scratch surfaces